

valvole G1/2" azionamento elettropneumatico

solenoid actuated valves - G1/2"

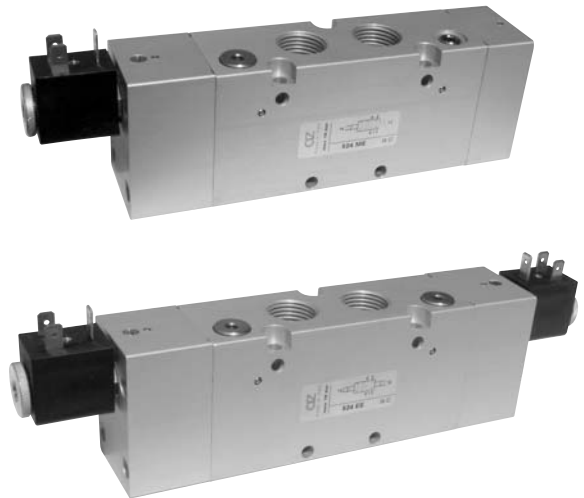

- Valvole a spola 3/2-5/2-5/3 con attacchi filettati G1/2"
3/2-5/2-5/3 spool valves with G1/2" threaded ports
- Elevatissima portata
Very high flow rate
- Montaggio in linea
Installation in-line
- Comandi elettrici con azionamento manuale bistabile
Solenoid pilots with detented manual override as standard
- Multifunzionalità e adattabilità
Multifunction feature



I prodotti di seguito indicati sono venduti senza bobine, da acquistarsi separatamente (vedi pag. 244).

The following listed products are sold without coils, which are bought separately (refer to page 244).

Kit ricambi - spare parts

02.030.2 : per valvole a 3/2 vie [for 3/2 way valves] ME - ME AS - MC

02.031.2 : per valvole a 5/2 vie [for 5/2 way valves] ME - ME AS - MC

02.032.2 : per valvole a 3/2 vie [for 3/2 way valves] EE - EE AS - CC

02.033.2 : per valvole a 5/2 vie [for 5/2 way valves] EE - EE AS - CC

02.034.2 : per valvole a 5/3 vie [for 5/3 way valves] EE - EE AS - CC

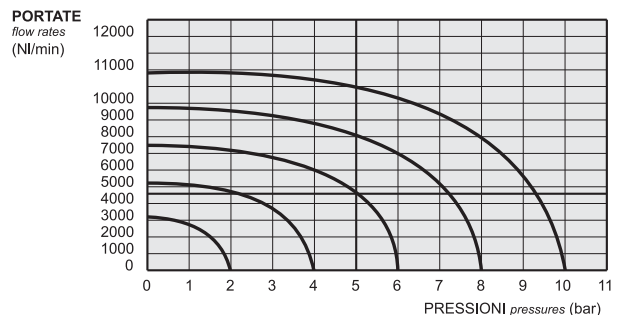

Tempi di risposta - response times

monostabile <i>mono-stable</i>	TRA (14): 39 ms TRR (12): 60 ms
bistabile <i>bi-stable</i>	TRA (14): 90 ms TRR (12): 90 ms

Materiali

Corpo: alluminio 11S

Molle: INOX

Guarnizioni: NBR

Spola: INOX

Parti interne: ottone OT58

Materials

Body: aluminium 11S

Springs: stainless steel

Seals: NBR

Spool: stainless steel

Internal parts: brass OT58

Diametro nominale <i>Nominal orifice</i>		13 mm	
Portata nominale a 6 bar, Δp 1 bar <i>Nominal flow rate at 6 bar, Δp 1 bar</i>		4600 NI/min	
Temperatura di esercizio <i>Temperature range</i>		max +60°C	
Pressione di esercizio <i>Working pressure</i>	al. interna monost. [monost. internal air supply]	al. interna bist. [bi-stable internal air supply]	alim. separata [separate air supply]
	2.5 ... 10 bar 0.25 ... 1 MPa	1 ... 10 bar 0.1 ... 1 MPa	-0.9 ... 10 bar -0.09 ... 1 MPa
Pressione di azionamento (per alimentazione separata) <i>Actuating pressure (for separate air supply)</i>	monostabile [mono-stable]		bistabile [bi-stable]
	2.5 ... 10 bar 0.25 ... 1 MPa		1 ... 10 bar 0.1 ... 1 MPa
Fluido <i>Fluid</i>	Aria filtrata 50μ con o senza lubrificazione <i>50μ filtered, lubricated or non lubricated air</i>		

valvole G1/2" azionamento elettropneumatico

solenoid actuated valves - G1/2"



Multifunzionalità e adattabilità della valvola

La funzione della valvola può essere variata in ogni momento secondo necessità cambiando la posizione dei tappi da M5 e G1/8" collocati nel corpo secondo gli schemi sottoriportati.

La valvola è fornita nella configurazione richiesta al momento dell'ordine. Eventuali tappi aggiuntivi possono essere ordinati separatamente.

Multifunction feature of the valve

The function of the valve can be changed in any moment. To do this it is enough to change the position of the plugs M5 and G1/8", which are inserted into the body according to the scheme.

The valve is supplied in the configuration specified on the order. More plugs can be ordered separately.

324 ME
524 ME

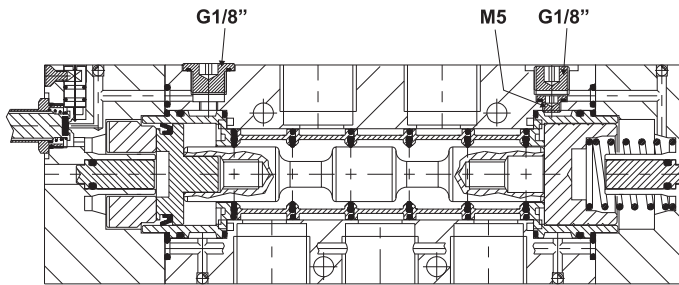

324 ME AS
524 ME AS

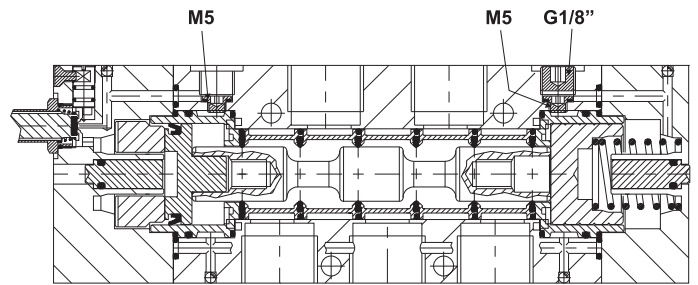

324 EE
524 EE

5243C EE
5243A EE
5243P EE

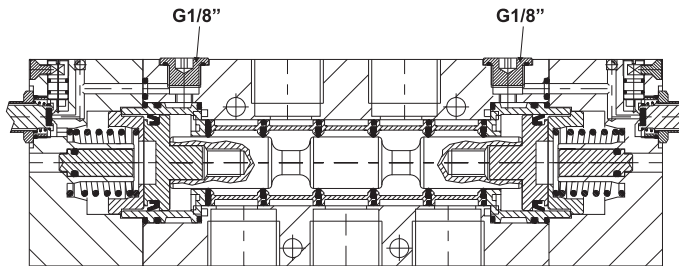

324 EE AS
524 EE AS

5243C EE AS
5243A EE AS
5243P EE AS

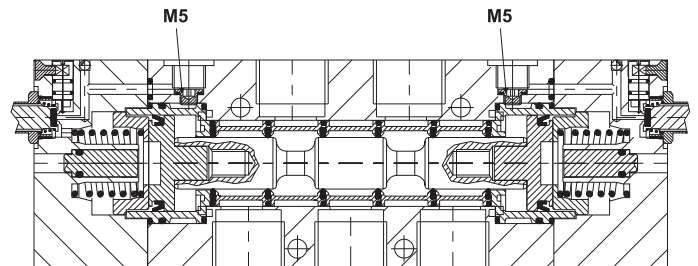

valvole G1/2" azionamento elettropneumatico

solenoid actuated valves - G1/2"



324 ME

3/2 1/2" NC comando elettrico - ritorno a molla

3/2 1/2" NC solenoid pilot - spring return

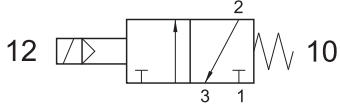

324 ME AS

3/2 1/2" comando elettrico alimentazione separata - ritorno a molla

3/2 1/2" solenoid pilot with separate air supply - spring return

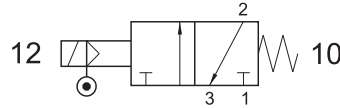

324 MEA

3/2 1/2" NA comando elettrico - ritorno a molla

3/2 1/2" NO solenoid pilot - spring return

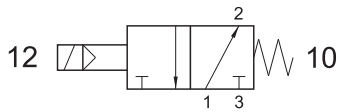

324 EFP

3/2 1/2" NC comando elettrico - ritorno a molla pneumatica

3/2 1/2" NC solenoid pilot - pneumatic spring return

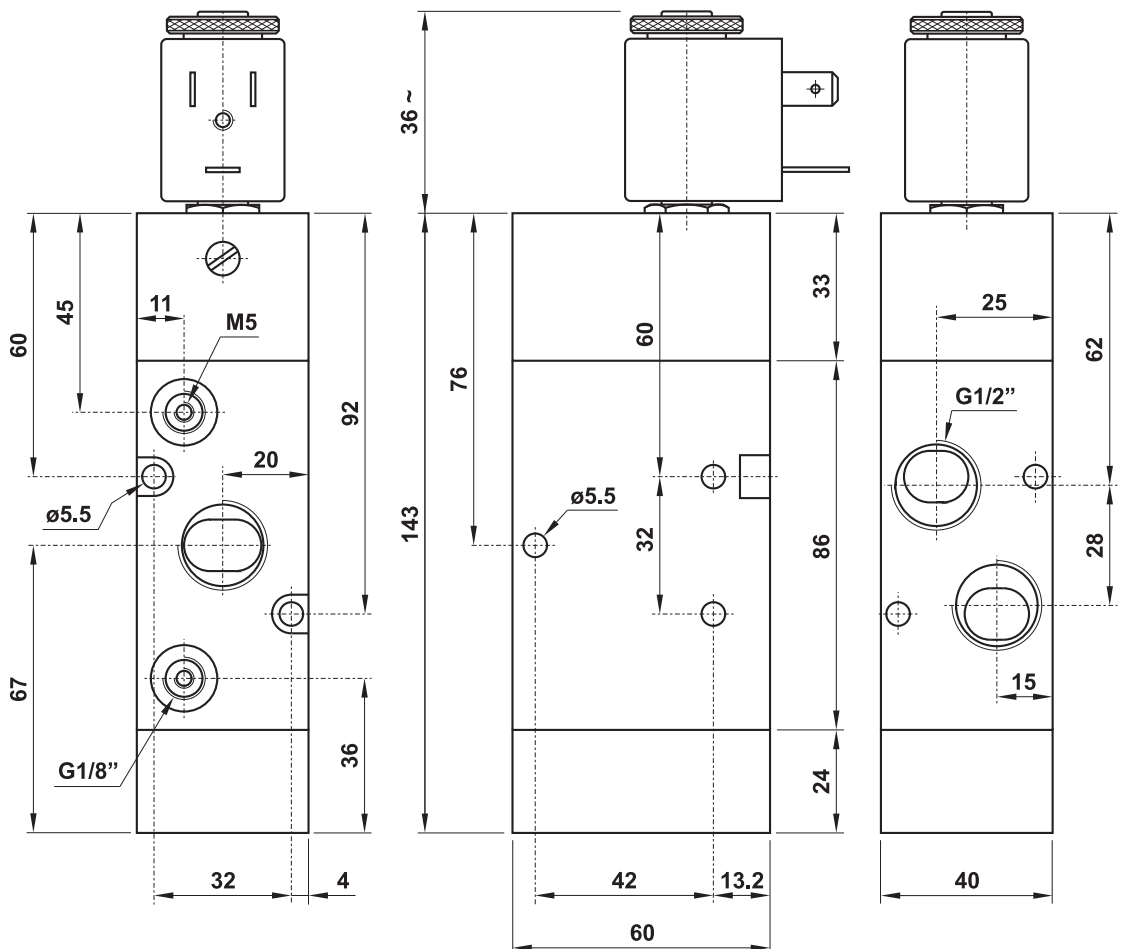
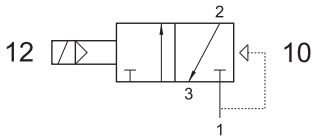

valvole G1/2" azionamento elettropneumatico

solenoid actuated valves - G1/2"



324 EE

3/2 1/2" doppio comando elettrico

3/2 1/2" double solenoid pilot

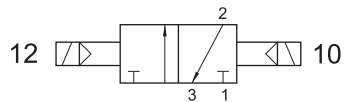

324 EE AS

3/2 1/2" doppio comando elettrico alimentazione separata

3/2 1/2" double solenoid pilot with separate air supply

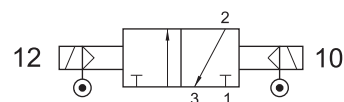

324 EED

3/2 1/2" doppio comando elettrico - con differenziale

3/2 1/2" double solenoid pilot - with differential

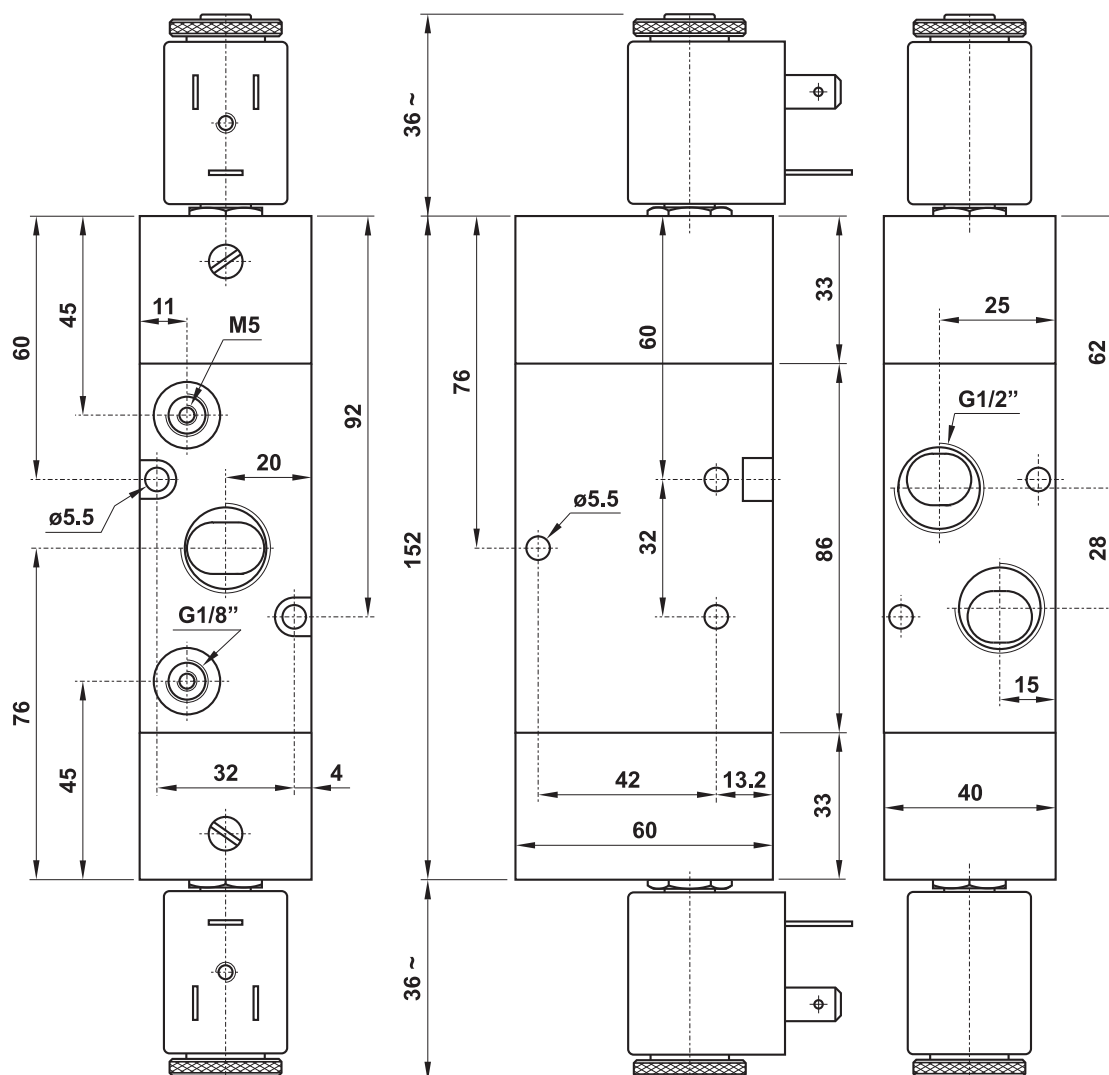
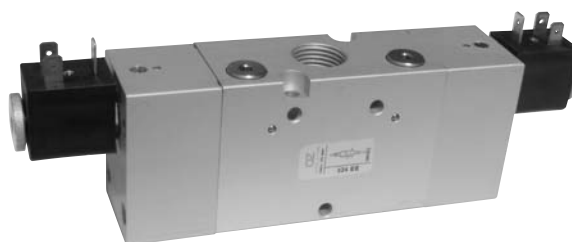
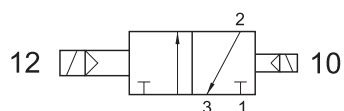

valvole G1/2" azionamento elettropneumatico

solenoid actuated valves - G1/2"



524 ME

5/2 1/2" comando elettrico - ritorno a molla

5/2 1/2" solenoid pilot - spring return

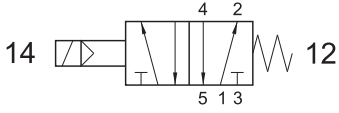

524 ME AS

5/2 1/2" comando elettrico alimentazione separata - ritorno a molla

5/2 1/2" solenoid pilot with separate air supply - spring return

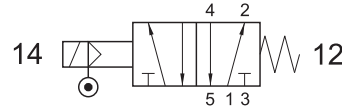

524 EFP

5/2 1/2" comando elettrico - ritorno a molla pneumatica

5/2 1/2" solenoid pilot - pneumatic spring return

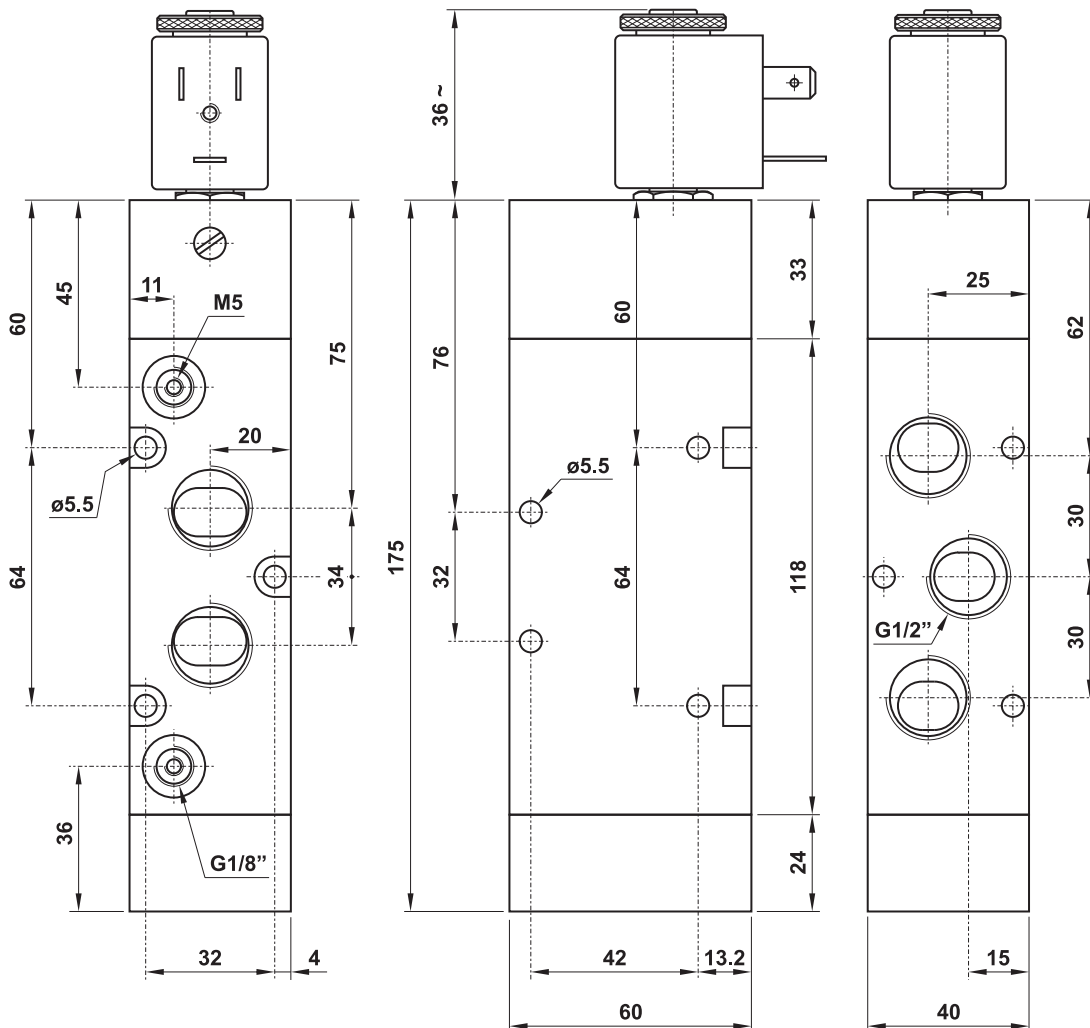
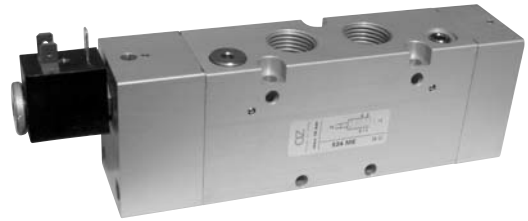
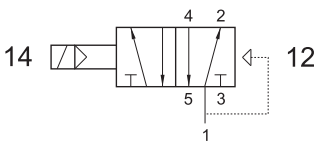

valvole G1/2" azionamento elettropneumatico

solenoid actuated valves - G1/2"



524 EE

5/2 1/2" doppio comando elettrico

5/2 1/2" double solenoid pilot

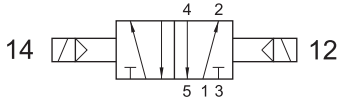

5243C EE

centri chiusi
closed centres

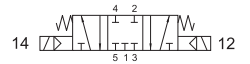

5243A EE

centri aperti
open centres

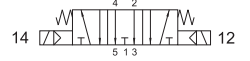

5243P EE

centri in pressione
pressurized centres

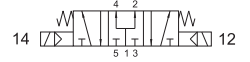

5/3 1/2" doppio comando elettrico

5/3 1/2" double solenoid pilot

524 EED

5/2 1/2" doppio comando elettrico - con differenziale

5/2 1/2" double solenoid pilot - with differential

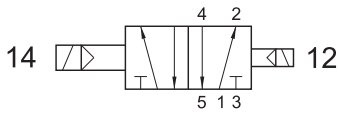

5243C EE AS

centri chiusi
closed centres

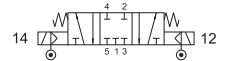

5243A EE AS

centri aperti
open centres

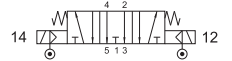

5243P EE AS

centri in pressione
pressurized centres

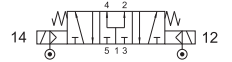

5/3 1/2" doppio comando elettrico alimentazione separata

5/3 1/2" double solenoid pilot with separate air supply

524 EE AS

5/2 1/2" doppio comando elettrico alimentazione separata

5/2 1/2" double solenoid pilot with separate air supply

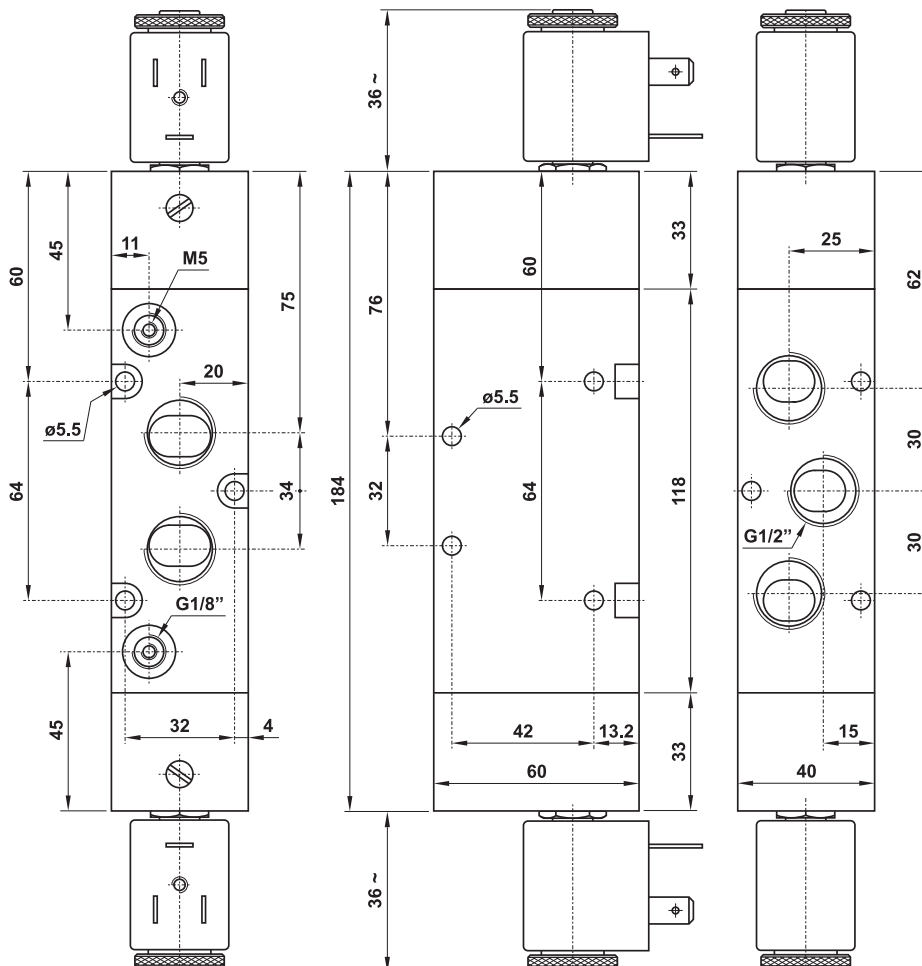
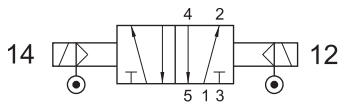

collettori per valvole a spola G1/2"

gang manifolds for spool valves G1/2"

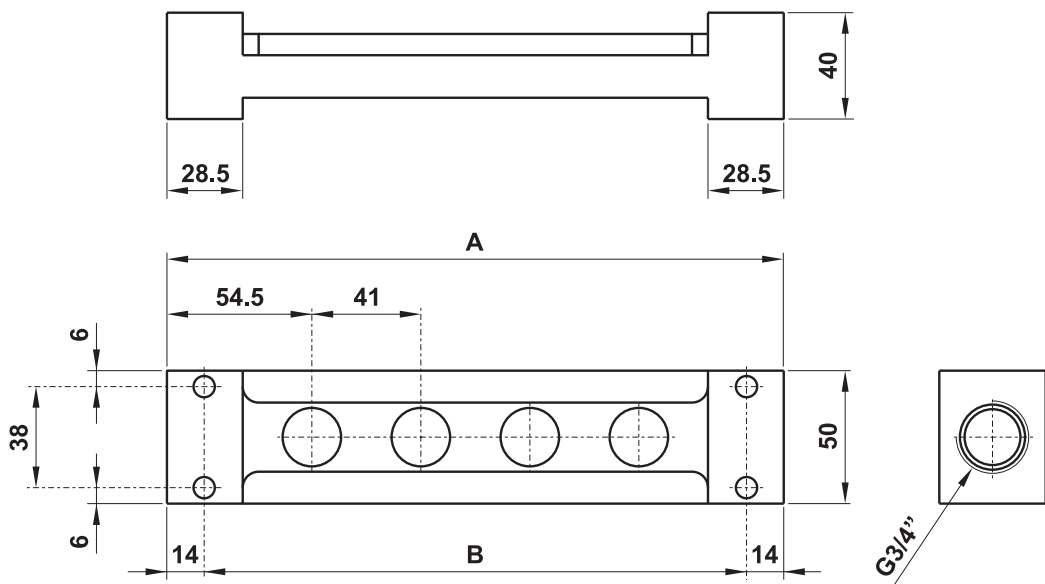

modello model	nr. posiz. no. stations	A	B
02.042.2	2	150	122
02.043.2	3	191	163
02.044.2	4	232	204

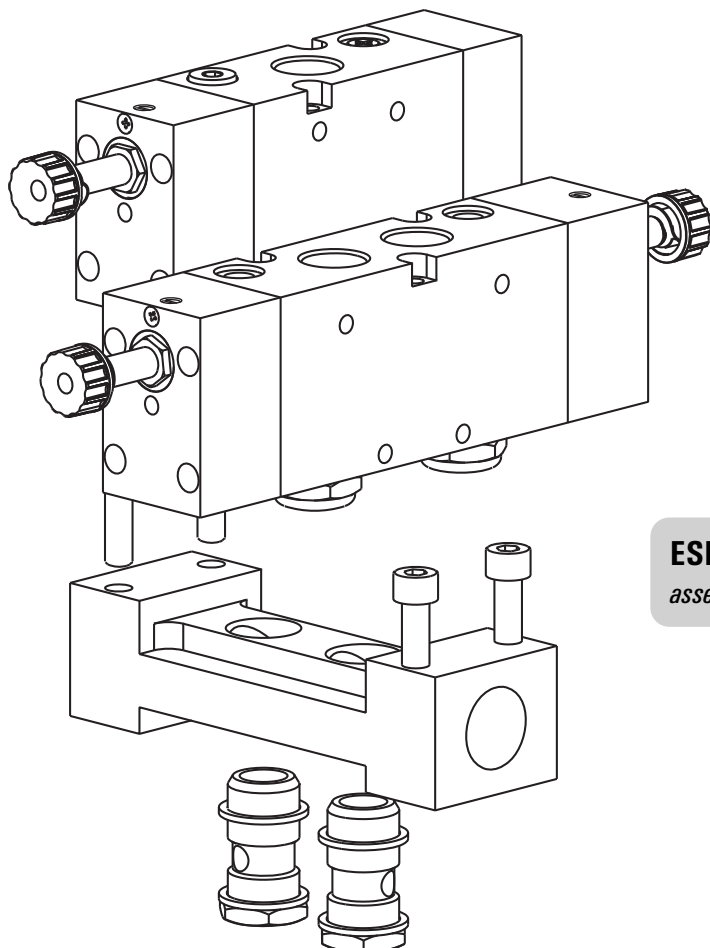
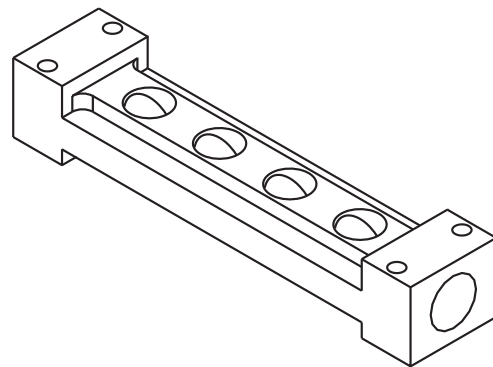

ESEMPIO DI MONTAGGIO

assembly example

Questi collettori in alluminio possono essere utilizzati per formare una batteria di valvole a spola G1/2". Sono venduti con tutti i particolari necessari all'assemblaggio.

These gang manifolds in aluminium can be used to assemble more G1/2" spool valves together. Each component is sold with all necessary pieces for installation.

bobine e connettori 22 mm

22 mm coils and connectors



22 mm



temperatura max di esercizio	+50°C	max working temperature
inserimento	ED 100%	duty cycle
protezione con connettore correttamente montato	IP 65	protection with connector correctly mounted
tolleranza di tensione	±10%	tension tolerance

- a richiesta basso assorbimento 1.5W
low consumption (1.5W) on request

codice code	tensione tension	consumo - power	
		a regime rated	di spunto inrush
00.167.0	12V DC	3W	
00.028.0	24V DC	3W	
00.029.0	24V 50/60Hz	5VA	7.5VA
00.030.0	110V 50/60Hz	5VA	7.5VA
00.031.0	220V 50/60Hz	5VA	7.5VA

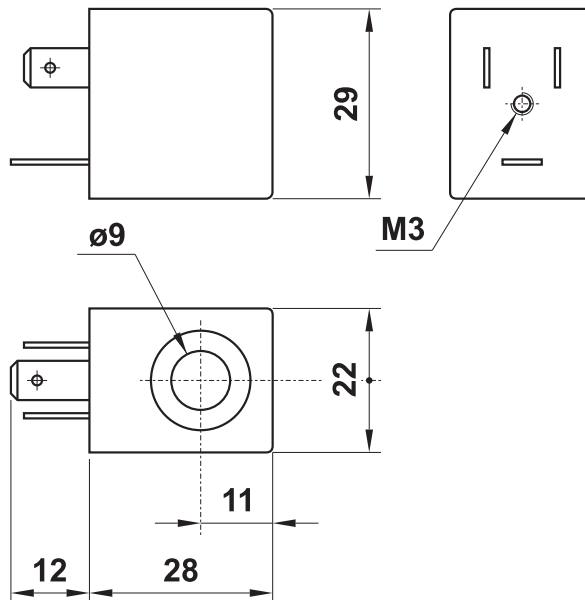

codice code	colore colour	cavo cable	tipo type
00.197.0	nero black	PG09	normale standard
00.344.0	trasparente transparent	PG09	con LED 24V with LED 24V
00.345.0	trasparente transparent	PG09	con LED 24V e VDR with LED 24V and VDR
00.346.0	trasparente transparent	PG09	con LED 115V with LED 115V
00.347.0	trasparente transparent	PG09	con LED 115V e VDR with LED 115V and VDR
00.394.0	trasparente transparent	PG09	con LED 230V with LED 230V
00.395.0	trasparente transparent	PG09	con LED 230V e VDR with LED 230V and VDR

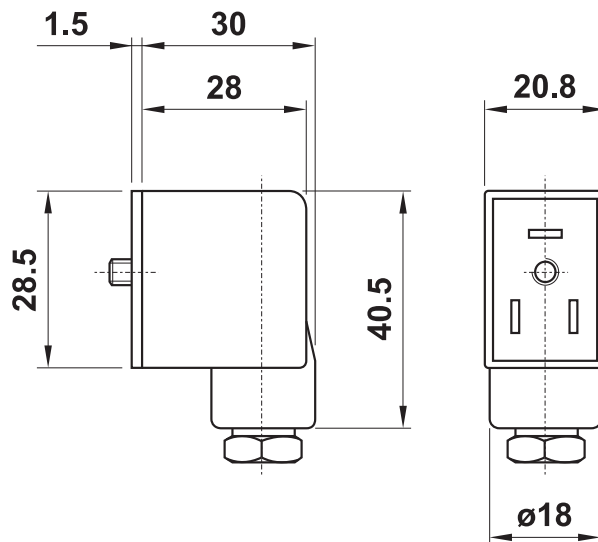

PEZZI DI RICAMBIO - spare parts

<p>canotto per elettropilota armature for solenoid pilot</p> <p>NC : 00.088.0 NA (NO) : 00.306.0</p>	<p>ghiera in alluminio e rondella aluminium nut and elastic ring</p> <p>00.125.2</p>
	<p>ghiera in plastica nut in plastic material</p> <p>00.186.0</p>