

NOGIX

Instruction Manual for Electric Actuator

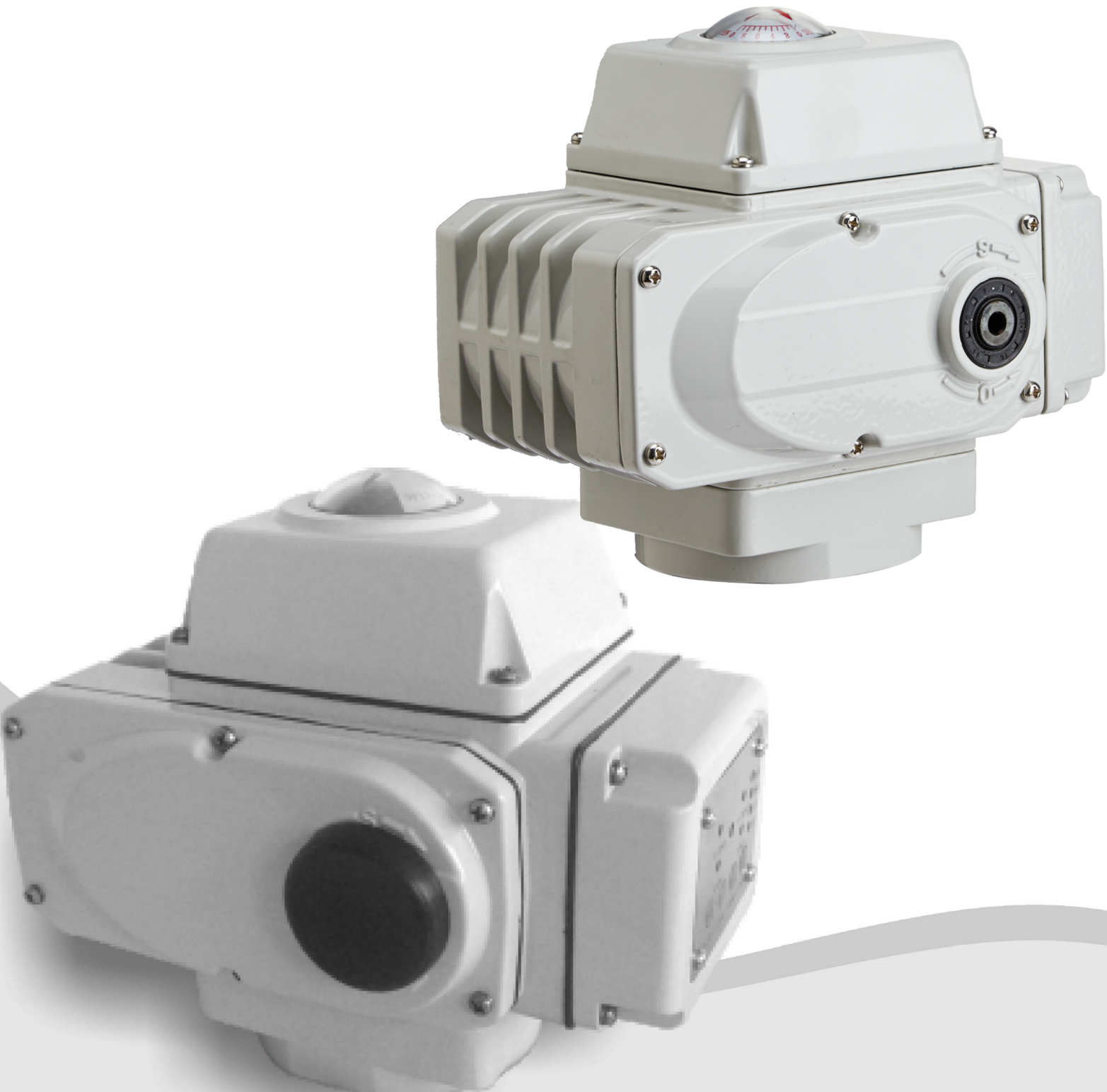

CONTENTS

| | |
|--|----|
| Product Introduction | 1 |
| Dimension of NOG-02/05/10/20/40/60 Series | 2 |
| Performance Parameter of NOG-02/05 Series | 3 |
| Performance Parameter of NOG-10/20/40/60 | 4 |
| Series Performance Parameter of NOG-100/200 | 5 |
| Performance Parameter of Modulating Type Series | 6 |
| Wiring Diagram | 7 |
| Power, Voltage and Installation | 9 |
| Adjustment of On-off Type | 10 |
| Adjustment of Potentionmeter and Modulating Type | 11 |
| Model Selection | 17 |
| Failure and Countermeasure | 20 |

Product Introduction

The Electric Actuator is distinguished by its special design, beautiful appearance, great performance and long-time operation. The rotary valve electric actuator will win customers' hearts by its supreme performance.

- ◆ Powerful function: Modulating, proportional, on-off, and various output signal;h
- ◆ Small Size: 35% smaller than other of the same kind;
- ◆ Light Weight: 35% lighter than other of the same kind ;
- ◆ Beautiful Appearance: Die-casting aluminium alloy cover can prevent disturbance of electromagnetic;
- ◆ Precision and Wear-resistance: Integration of worm wheel and output axle avoids the separation among keys and the forged brass alloy material is featured by high strength and good wear-resistance;
- ◆ Safety Guarantee: Tested by AC 1500V and can withstand it; F-grade insulation motor guarantees safe operation;
- ◆ Easy to Form Complete Set: 110V, 220V, 380V alternate current and direct current are all available for simple connection;
- ◆ Easy Application: No oil or point inspection is needed; waterproof, antirust and optional installation angle;
- ◆ Protection Appliance: Double limits, over-hot protection, overload protection;
- ◆ Various Motion Time: 9s, 13s, 15s, 30s, 50s, 100s (Set Before Delivery);
- ◆ Antirust and Anti-corrosion: Whole machine support, coupler and screws are made of stainless steel;
- ◆ Intelligent Numerical Control: Intelligently control module is built in the actuator body so that there is no need to mount positioner. Digit setting and adjusting, highly accuration and self-diagnosis can be realized.

Appearance and Parts Name

| | |
|----|------------------------------|
| 1 | Case Body |
| 2 | Opening Mete |
| 3 | Inlet Wire Lock |
| 4 | Rubber Cover of Handle Shaft |
| 5 | No-Bracket Installation |
| 6 | Gear Box Cover |
| 7 | Electric Cover |
| 8 | Wiring Cover |
| 9 | Handle Shaft Cover |
| 10 | Output Shaft |
| 11 | Adapter |

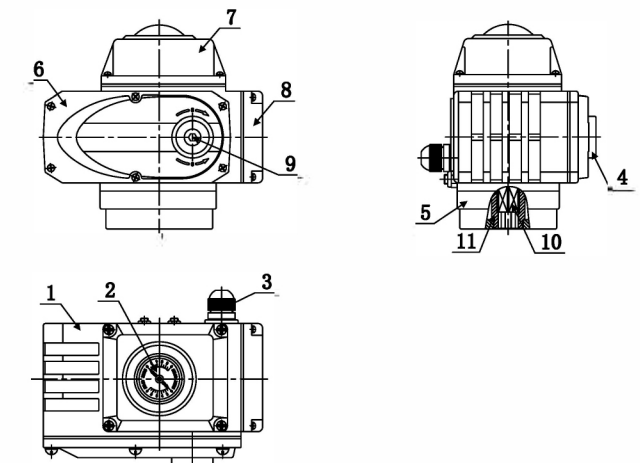

NOG 10 Performance Parameter

| Model | NOG 10 | | | | |
|----------------------------|--|------|-------|-------|-------|
| Power Supply(V) | DC24 | AC24 | AC110 | AC220 | AC380 |
| Output Toque(Nm) | 100 | | | | |
| Motion Time(S) | 10 | 30 | | | |
| Rotary Angle (°) | 0~360 | | | | |
| Motor Power(W) | 20 | 25 | | | |
| Rated Current(A) | 0.85 | 3 | 0.7 | 0.32 | 0.2 |
| Weight(kg) | 4 | 4.3 | | | |
| Insulation Resistance (MΩ) | DC24V: 100/250VDC AC110/220V/380V: 100/500VDC | | | | |
| Voltage Resistance | DC24V: 500VAC, AC110/220V: 1500VAC, AC380V: 1800VAC .(1Min.) | | | | |
| Protection Level | IP68 | | | | |
| Installation Position | 360-Degree Optional Direction | | | | |
| Electriad connection | M181.5 Water-proof Cable Connector, Electric Power Wire, Signal Wire | | | | |
| Ambient Temp. | -30°C ~ +60°C | | | | |
| Circuit Control | B, S, K, R, TA, D, H | | | | |
| Optional Function | I. Over Torque Protectors II. Dehumidify Heater | | | | |

NOG 20/40/60 Performance Parameter

| Model | NOG 20 | | | | | NOG 40 | | | | | NOG 60 | | | | |
|----------------------------|---|-------|-------|-------|-------|--------|-------|-------|-------|-------|--------|-------|-------|-------|-------|
| Power Supply(V) | DC24 | AC24 | AC110 | AC220 | AC380 | DC24 | AC24 | AC110 | AC220 | AC380 | DC24 | AC24 | AC110 | AC220 | AC380 |
| Output Toque(Nm) | 200 | | | | | 400 | | | | | 600 | | | | |
| Motion Time(S) | 12 | 30/60 | | | | 15 | 30/60 | | | | 20 | 45/60 | | | |
| Rotary Angle (°) | 0~90 | | | | | 0~90 | | | | | 0~90 | | | | |
| Motor Power(W) | 40 | | | | | 70 | 90 | | | | 90 | | | | |
| Rated Current(A) | 1.2 | 7.5 | 1.6 | 0.88 | 0.4 | 2.5 | 9 | 2.2 | 1 | 0.48 | 2.5 | 9 | 2.2 | 1 | 0.5 |
| Weight(kg) | 8.7 | 9.3 | | | | 8.8 | 10 | | | | 8.8 | 10 | | | |
| Insulation Resistance (MΩ) | DC24V: 100/250VDC AC110/220V/380V: 100/500VDC | | | | | | | | | | | | | | |
| Voltage Resistance | DC24V: 500VAC AC110/220V: 1500VAC AC380V: 1800VAC. (1Minute) | | | | | | | | | | | | | | |
| Protection Class | IP68 | | | | | | | | | | | | | | |
| Installation Position | 360-Degree Optional Direction | | | | | | | | | | | | | | |
| Electrical Connection | M181.5 Water-proof Cable Connectors, Electric Power Wire, Signal Wire | | | | | | | | | | | | | | |
| Ambient Temp. | -30°C ~ +60°C | | | | | | | | | | | | | | |
| Circuit Control | B, S, K, R, A, D, H, T | | | | | | | | | | | | | | |
| Optional Function | I. Over Torque Protectors II. Dehumidify Heater | | | | | | | | | | | | | | |

Performance Parameter of NOG 100/200 Series

| Performance | Model Power(V) | NOG 100 | | | | NOG 200 | | | |
|---------------------------|----------------|---|-------|-------|-------|---------|-------|-------|-------|
| | | AC24 | AC110 | AC220 | AC380 | AC24 | AC110 | AC220 | AC380 |
| Motor Power(W) | | 100 | | | | 100 | | | |
| Rated Current(A) | | 9 | 2.2 | 1.2 | 0.48 | 9 | 2.2 | 1.2 | 0.48 |
| Output Torque(Nm) | | 800/1000 | | | | 2000 | | | |
| Motion Time (S) | | 30/50 | | | | 100 | | | |
| Circuit Control | | B, S, K, R, A, D, H, T | | | | | | | |
| Rotary Angle (°) | | 0~90 | | | | | | | |
| Weight(kg) | | 11.2 | | | | 11.8 | | | |
| Voltage Resistance | | AC110V/AC220V:1500VAC, AC380V:1800VAC(Minute) | | | | | | | |
| Insulation Resistance(MΩ) | | 100MΩ /500VDC | | | | | | | |
| Protection Class | | IP-68 | | | | | | | |
| Ambient Temp. | | -30°C ~ +60°C | | | | | | | |
| Installation Angle | | 360-Degree Optional Direction | | | | | | | |
| Case Body Material | | Die-Casting Aluminium Alloy | | | | | | | |
| Optional Function | | I. Over Torque Protectors II. Dehumidify Heater | | | | | | | |

Performance Parameter of Modulating Type

| Model | NOG 05A | NOG 10A | NOG 20A | NOG 40A | NOG 60A | NOG 100A | NOG 200A |
|-----------------------|--|--|-------------------|----------------|----------------|------------------|------------------|
| | Power | DC24V/AC24V, AC110V, AC220V, AC380V, 50/60HZ | | | | | |
| Performance | | | | | | | |
| Motor Power (W) | 15W | 25W | 40W | 90W | 90W | 100W | 100W |
| Rated Current (A) | 0.24A (AC220V) | 0.32A (AC220V) | 0.88A (AC220V) | 1A (AC220V) | 1A (AC220V) | 1.2A (AC220V) | 1.2A (AC220V) |
| Output Torque (N.m.) | 50 Nm | 100 Nm | 200 Nm | 400 Nm | 600 Nm | 1000 Nm | 2000 Nm |
| Motion Time (S) | 20S | 30S | 30S | 30S | 45S | 50S | 100S |
| Rotary Angle (°) | 0~360° | | | 0~90° | | | |
| Input Signal | 4~20mA.DC、1~5V.DC、0~10V.DC (Others could be set before delivery) | | | | | | |
| Output Signal | 4~20mA.DC (Others could be set before delivery) | | | | | | |
| Precision Grade | 1% | | | | | | |
| Weight | 2.7kg | 4.3kg | 9.3kg | 10kg | 10kg | 11.2kg | 11.8kg |
| Voltage Resistance | DC24V:500VAC/1min | | | 1500VAC/1min | | | |
| Insulation Resistance | DC24V:100MΩ/300VDC | | | 100MΩ/500VDC | | | |
| Protection Class | IP-68 | | | | | | |
| Ambient Temp. | -30℃ ~ +60℃ | | | | | | |
| Installation Angle | 360-Degree Optional Direction | | | | | | |
| Case Body Material | Die-Casting Aluminium Alloy | | | | | | |
| Optional Function | I. Over Torque Protectors II. Dehumidify Heater | | | | | | |

Wiring Diagram

Open Switch and Close Switch are strictly prohibited to be connected at the same time.

Z: 02 On-Off Type

The actuator is equipped with dedicated cable (30cm) to distribute wiring for power and full closed & full open output signal (NPN Transistor & Collector Current) .

Wiring Instructions:

1. Wiring distribution shall be conducted by qualified electrical engineer in accordance with electrical equipment technical standard.
2. It's prohibited to conduct wiring distribution when it's raining or the air is highly humid.
3. Make sure the wiring diagram is correctly connected.
4. Dedicated cable is built in the actuator so that internal wiring is not needed.
5. Top cover is strictly forbidden. (Cable is already available)
6. It's strictly forbidden to connect Open Switch and Close Switch simultaneously when the power is on.

B: On-Off Type (Standard)

Valve can be controlled to open and close by the on-off circuit and the circuit will output a group of active position signal to indicate the valve is in full close or full open position.

Wiring Instruction:

1. Connect terminal 1 with null line.
2. When terminal 2 connects with phase line, it indicates "Opening" is in operation.
3. When terminal 3 connects with phase line, it indicates "Closing" is in operation.
4. When "Opening finishes its operation, the signal lamp connected with terminal 4 will be on.
5. When "Closing finishes its operation, the signal lamp connected with terminal 5 will be on.

S: Passive Contact Type

Valve can be controlled to open and close by the on-off circuit and the circuit will output a group of passive position signal to indicate the valve is in full close or full open position.

Wiring Instruction:

1. Connect terminal 1 with null line.
2. When terminal 2 connects with phase line, it indicates "Opening" is in operation.
3. When terminal 3 connects with phase line, it indicates "Closing" is in operation.
4. Terminal 4 is the passive contact common port.
5. When "Opening finishes its operation, terminal 5 will output Fully Open Signal.
6. When "Closing finishes its operation, terminal 5 will output Fully Close Signal.

K: With Position Generator Type

Valve can be controlled to open and close by the on-off circuit and the circuit will output current signal corresponding to the openness angle of valve.

Wiring Instruction:

1. "N" is null line and "L" is phase line.
2. When "L" is connected with "On", valve is in open operation.
3. When "L" is connected with "Off", valve is in close operation.
4. Connect "+" of output terminal with the positive pole of output signal and "-" with negative pole of output signal.

R: Opening Signal Type

Valve can be controlled to open and close by the on-off circuit and the circuit will output resistant signal corresponding to the openness angle of valve.

Wiring Instruction:

1. Terminal 1 connect with null line. Terminal 5 is the lift arm of potentiometer.
2. When terminal 2 connects with phase line, valve will open; when terminal 3 connects with phase line, valve will close.
3. Terminal 4 is the low side of potentiometer. When valve opens, the resistance between terminal 4 and 5 will increase with the opening degree.
4. Terminal 6 is the high side of potentiometer. When valve close, the resistance between terminal 4 and 5 will increase with the closing degree.

Wiring Diagram

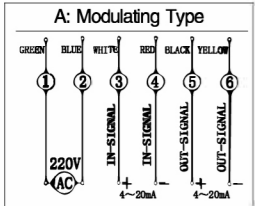
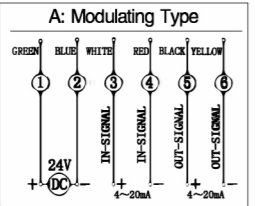



A: Modulating Type

The opening or closing is realized by the standard signal through external computer or industry meter. Meanwhile, the corresponding standard signals will be output.

Wiring Instrument:

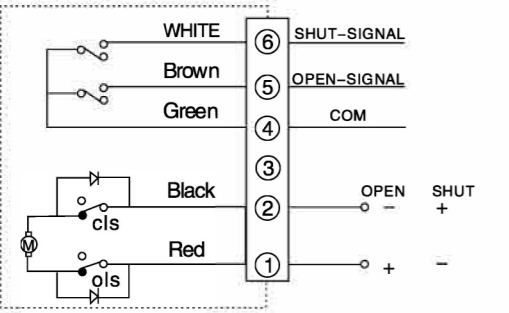
1. Connect "N" of input terminal with null line and "L" with phase line.
2. Connect the "+" of external control terminal with positive pole of input signal, "-" with negative pole of input signal.
3. Connect the "+" of feedback terminal with positive pole of input signal, "-" with negative pole of input signal.



D: Direct Current On-Off Type

Opening or closing operation of valve can be realized by switching the positive and negative pole of external direct current. Meanwhile, a group of passive contact signal will be output to indicate fully openness or close of valve.

Wiring Instrument:

1. Valve will open when terminal 1 is connected with positive pole and terminal 2 with negative pole.
2. Valve will close when terminal 1 is connected with negative pole and terminal 2 with positive pole.
3. Terminal 4 is the passive contact common end.
4. When "Opening" finishes its operation, terminal 5 will output Fully Open Signal.
5. When "Closing" finishes its operation, terminal 6 will output Fully Close Signal

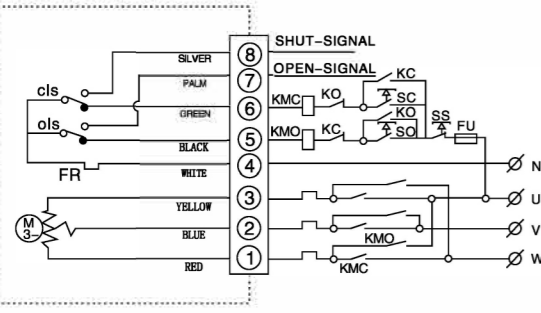

H: Three-Phase On-Off Type

Valve can be controlled to open and close by the on-off circuit and the circuit will output a group of active position signal to indicate the valve is in full close or full open position.

Wiring Instruction:

1. Connect terminal 1, 2, 3 with 3-phase alternate current. The motor will be operated to rotate clockwise and anticlockwise through external phase inverter circuit.
2. Terminal 4 is the common port of external control circuit.
3. Terminal 5 is "open" operation control.
4. Terminal 6 is "close" operation control.
5. When "Opening" finishes its operation, terminal 7 will output Fully Open Signal.
6. When "Closing" finishes its operation, terminal 8 will output Fully Close Signal.

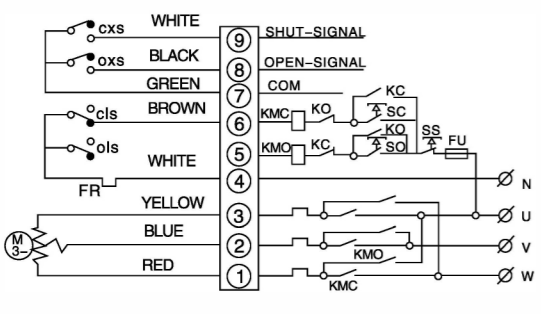

T: Three-Phase Passive Contact Type

Valve can be controlled to open and close by the on-off circuit and the circuit will output a group of active position signal to indicate the valve is in full close or full open position.

Wiring Instruction:

1. Terminal 1, 2, 3 connected with 3-phase power. By means of the external phase reversing circuit, running normally or reversibly of motor.
2. Terminal 4 is the common port of external control circuit.
3. Terminal 5 is "open" operation control.
4. Terminal 6 is "close" operation control.
5. Terminal 7 is passive contact common port.
6. When "Opening" finishes its operation, terminal 8 will output Fully Open Signal.
7. When "Closing" finishes its operation, terminal 9 will output Fully Close Signal.

Power, Voltage

Please choose power voltage according to product nameplate or wiring diagram. Available voltages are listed as followings: AC380V ± 10% 50/60HZ; AC220V ± 10% 50/60HZ; DC24V

*Notes: When choosing AC380V, pay attention to the sequence of phase line during wiring and make sure travel switch can correctly control openness and close of valve. Otherwise, the actuator would be damaged.

Selection of Fuse and Circuit Breaker:

In order to protect the actuator, avoid short circuit and reduce injuries, A circuit breaker can be connected at the power input terminal of each actuator. Choose the appropriate fuse protection based on the following table.

| Model | Voltage | | | | |
|--------------|---------|--------|--------|---------|-------|
| | AC380V | AC220V | AC110V | AC24V | DC24V |
| NOG 05 | 2A | 2A | 3A | 5A | 5A |
| NOG 10 | 2A | 3A | 5A | 7A | 7A |
| NOG 20/40/60 | 3A/5A | 5A/7A | 7A/10A | 10A/11A | 15A |
| NOG 100/200 | 5A | 7A | 10A | 20A | |

Power lines of two or several electric devices can't be connected in parallel;
Several electric devices can't be controlled by the same connection point; Otherwise, you will lose control or the motor will be overheating.

Installation

Cautions for Indoor Installation

- ◆ Products can't be installed in the room with explosive air unless they are of anti-explosive;
- ◆ Please install a shield to cover the product for safety if the product is installed in a place with water or raw material;
- ◆ Space is needed for inlet wiring or manual operation.

Adjustment of On-Off Type

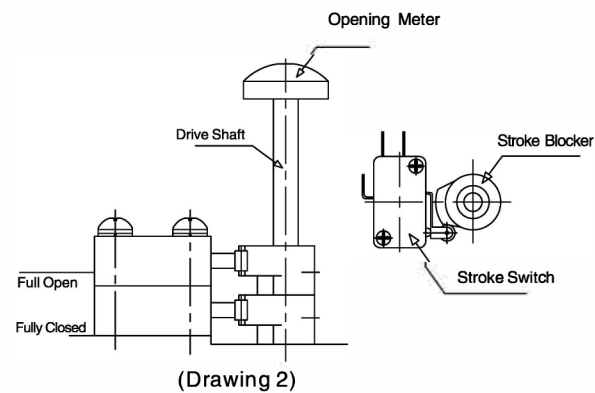

Adjustment of Limit Position Switch(Drawing2)

- ◆ Close the valve to fully closed position.
- ◆ Loosen the fastening screw of stroke blocker, turn the blocker below to activate the stroke switch. "Click" sound will be heard when the switch moves. Then fasten the screw. Adjustment way of full open position is the same as above.

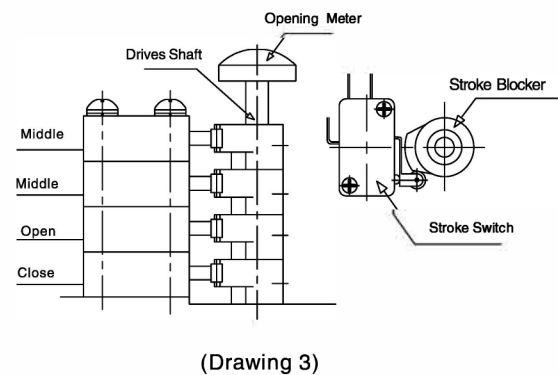

Adjustment of Middle Position Switch (Drawing 3)

- ◆ Operate the valve manually to desired position.
- ◆ Loosen the fastening screw of stroke blocker, turn the blocker below to activate the stroke switch. "Click" sound will be heard when the switch moves. Then fasten the screw. Adjustment way of full open position is the same as above.
- ◆ Motion position of two middle position switch can be adjusted in accordance with requirement.

Regulation of Mechanical Position-limiting (Drawing 4)

- ◆ Rotate the handle to fully open position.
- ◆ Loosen tightening nut and rotate to adjust screw in order to make it contact the mechanical blocker. Then, rotate screw semi-circle and fasten the nut. In anticlockwise direction for tightening nut.
- ◆ Using same method, operator could regulate mechanical link-stopper at wholly-closed position.

* Notes: Mechanical position limit must lag behind the electric position limit. Or the motor will be too hot.

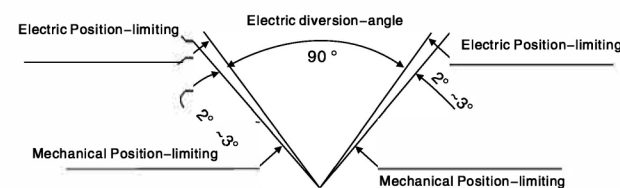
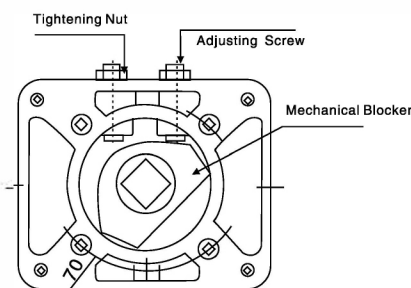

(Drawing 4)

Potentiometer Adjustment (Opening Type R, Modulating Type A) (Drawing 5)

- ◆ The resistance value of potentiometer is 1KΩ , 5KΩ ;
 - ◆ Rotate valve to fully closed position with handle;
 - ◆ Loosen screw of opening-gear and rotate opening gear for regulating potentiometer.
- Measure resistance value between 4 and 5 wiring terminals by universal meter, and make the resistance value achieve 10Ω , tighten opening gear, fixing screw. (If it is modulating type, resistance between RV and RS jacks shall be measured when connecting the seven-line connector).

*Notes: Potentiometer can be loosen for adjustment.

When fixing, pay attention to the mesh between potentiometer gear and opening gear, which can't be too large or small, or else, it would directly affect the precision of actuator.

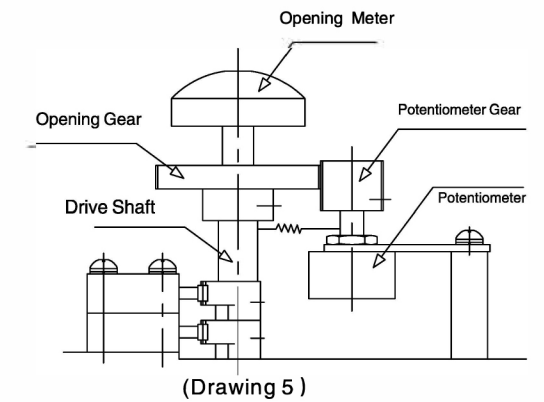

Adjustment of Modulating Type

Actuator Adjustment

- ◆ Before adjustment, you should understand the adjustment method of open and close angle. Adjust electric position-limiting, potentiometer and mechanical position-limiting of actuator in accordance with the fully openness and close of valve.

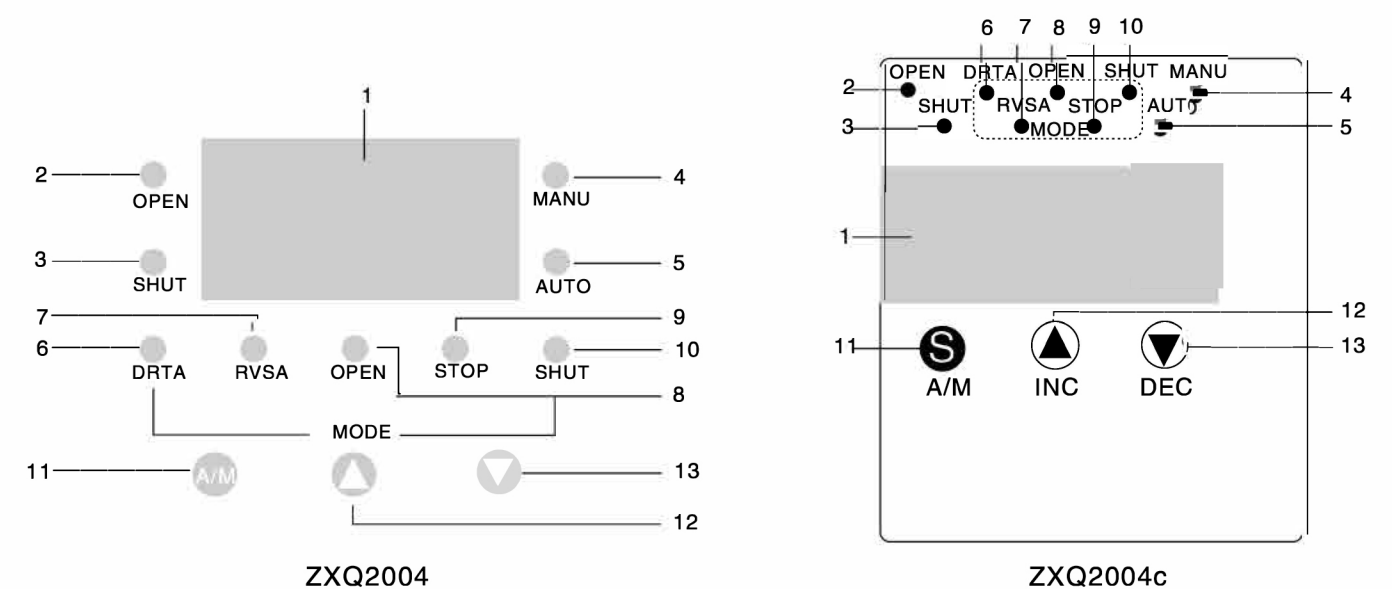

Positioner Panel

| | | | |
|-------------------|----|------------|---|
| Data Display | 1 | LED Window | Actual opening value, setting opening value, temperature inside positioner and setting parameter can be indicated by switching the buttons. |
| Status Indication | 2 | OPEN | Output control "open", relay will shut |
| | 3 | SHUT | Output control "closed", relay will shut |
| | 4 | MANU | Manual Status |
| | 5 | AUTO | Automation Status |
| Mode Indication | 6 | DRTA | Obverse-action mode, corresponding output of input signal is stated as following: 4mA-full(Normally set as fully open); 20mA-zero(Normally set as fully closed) |
| | 7 | RVSA | Reverse-action mode, corresponding output of input signal is stated as following: 4mA-zero (Normally set as fully closed); 20mA-full (Normally set as fully open) |
| | 8 | OPEN | Input signal suspension indicates "open", actuator opens to the largest position limit. |
| | 9 | STOP | Input signal suspension indicates "stop", actuator remains in the current position. |
| | 10 | SHUT | Input signal suspension indicates "closed", actuator closes to the largest position limit. |
| Button | 11 | A/M | Manual/Automatic switching button, button for parameter input, modification and switch |
| | 12 | ▲ | Value Increasing Button. It can be used to switch and indicate the set openness value in automatic status. It shows "open" in manual status. |
| | 13 | ▼ | Value Decreasing Button. It can be used to switch and indicate the inside temperature of positioner in automatic status. It shows "closed" in manual status. |

Wiring Introduction

ZXQ2004 intelligent positioner can be connected with electric actuator through one seven-line connector:

There is a group wiring tightened by six-line spring pressure on positioner(as shown in drawing 6), of which the N, L lines is connected with mid-line and phase-line of 220VAC single-phase circuit, two 4 ~ 20mA(or 1 ~ 5V) IN terminals is connected with control current (voltage), two 4 ~ 20mA terminals are to give feedback of current signal output, which can be connected with ammeter so as to display actual opening value of valve, it also can be not connected. $\Phi 1 \sim 2$ mm single-core or multi-core infrared insulated line (shown in diagram 7) can be adopted as connection line. It is suggested to fasten tightly and plate tin onto multi-core line if this line is adopted. It is suggested to insert single-core line or tin-plated multi-core line into the hole if there is spring resistance, insert another 4~5 mm. If the wire is soft, insert the wire into the hole and press the spring locking switch with straight screwdriver, insert another 4~5mm and loosen the switch, then the wire is locked. The wire can't be pulled out under normal circumstance. If it's needed to pull out the wire, press the switch beside the corresponding hole with screwdriver and then pull out the wire.

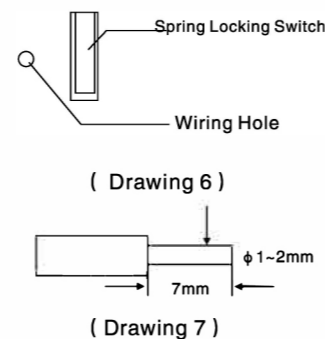

Setting Operation Intelligent Positioner

Connect the lines between given signal source, output signal measure meter (Disconnection is also allowed) and power supply according to wiring drawing.

- ◆ When the power is on, the actual opening value of valve would be displayed, and the positioner is under auto test status at this time.
- ◆ Press A/M button to switch to manual state, press ▲ and □ buttons separately to manually control the "open" and "close" of actuator.
- ◆ Under automatic status, press ▲ to check the set openness value of valve and the varying trend & stability of input signal.
- ◆ Under automatic status, press ? to observe the inside temperature of positioner. When it exceeds 70 centigrade, the positioner will cease the open and close control of actuator;
- ◆ Under automatic status, press A/M button for 4S to enter the setting parameter shown in the table below, the parameter value could be revised by pressing ▲ and □, see the operation progress diagram for details.

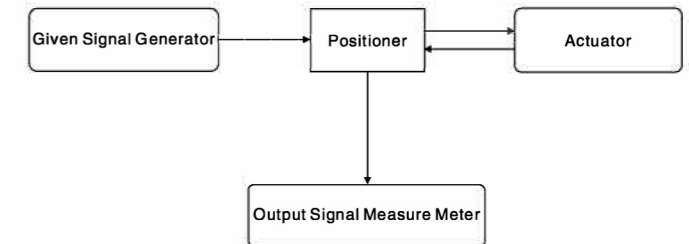

Setting Operation Intelligent Positioner

Parameter List

| Parameter | Indicated Value | Meaning | Set Value |
|-----------|-----------------|---|-----------|
| U0 | 00x.0 | X=1 Electronic braking is allowed, X=0 Electronic braking is not allowed | 1 |
| | 000.x | X=0 Positioning accuracy is not allowed but time readjustment is allowed. X=1,2,3 Time readjustment is not allowed but positioning accuracy is allowed | 0 |
| U1 | 00x.0 | Set positive and active action. X=0 is positive, x=1 is negative. | 1 |
| | 000.x | Signal Suspension Mode, x=0(neglection) x=1(open) x=2(stop) x=3(shut) | 2 |
| U2 | xxx.x | Control output lower limit value is $0 \leq U2 < 100$, manual zero and full setting will not be limited by the parameter | 0.0 |
| U3 | xxx.x | Control output upper limit value is $0 \leq U2 < 100$, manual zero and full setting will not be limited by the parameter | 100.0 |
| U4 | 00x.x | The precision is adjustable, it equals $x.x/100$ | 0.4 |
| | xxx.x | Operation password, (U5=003.1 is opening setting of entering the actuator) | |
| U5 | xxx.x | Actuator zero position confirmation, press ▲ and ? button. When it reaches full position, press A/M button for zero position confirmation, then enter U7. | |
| U6 U7 | xxx.x | Actuator zero confirmation. Press ▲ and ? button. When it reaches full position, press A/M button for full position confirmation. | |

Notes: Other parameters are reserved by manufacturer, Appendix will be taken for reference if needed.

Appendix: Other setting --see the drawing below for input signal, output signal setting

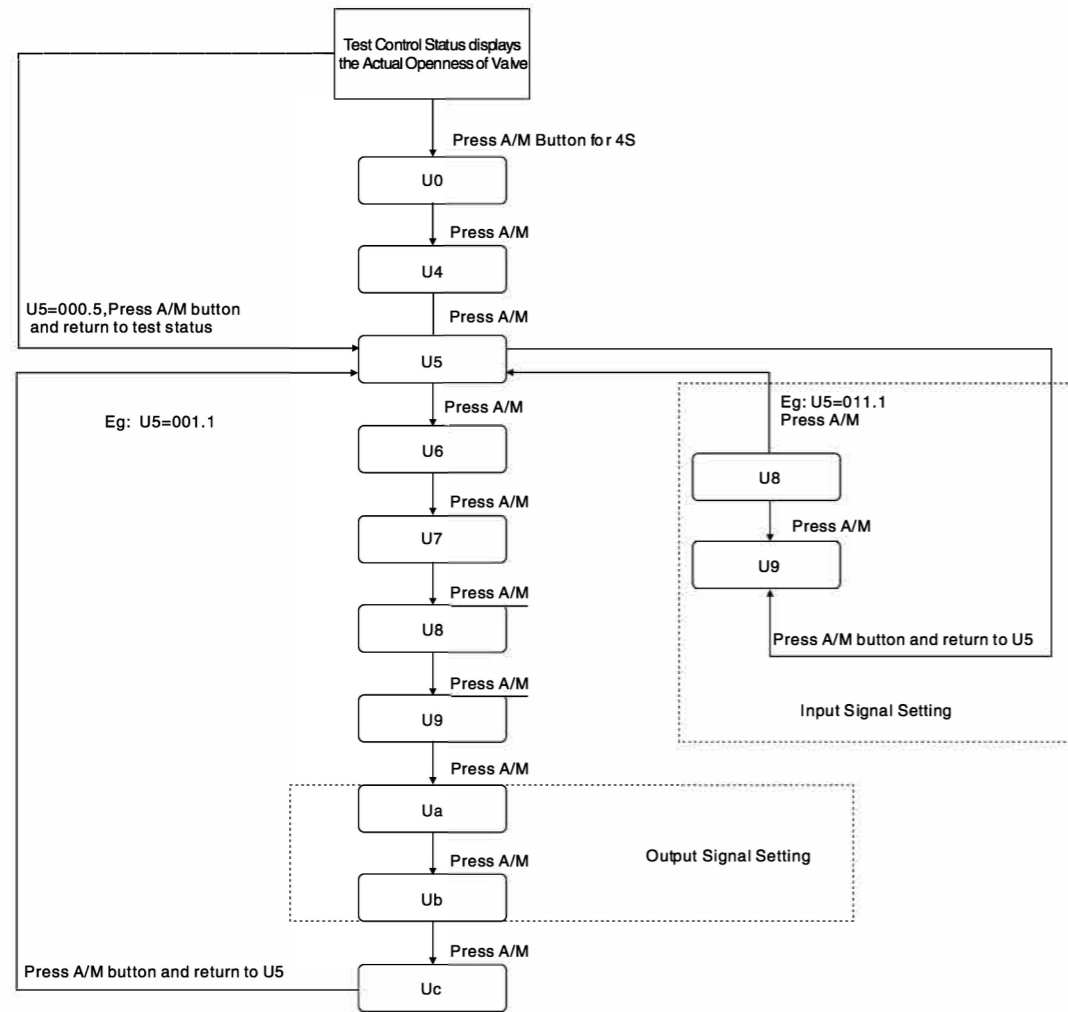

Updating Version Introduction of ZXQ2004 Model

1. A simplified automatic setting method is added. Press A/M button and ? button under automatic status and then release at the same time, the automatic setting will be activated (The function is the same as the automatic setting in method 2)
2. According to the setting method in the instruction manual, set full position (U7), press confirmation button (A/M), it will not return to U5 immediately. However, the electric valve will go to 10% position of setting measurement, then return to U5.
3. Another function of anti-blocking is added to the module. When the electric valve is blocked (10% of the full range time), the module will stop controlling output. It will check the blocking again after one minute. If the malfunction does not solved, it will check the valve again three times in one minute. Fault code and valve position value will be shown alternately on the display screen. If the fault still exists, the module ceases checking and displays fault module, then stops working.

The module will be back to normal by pressing the panel button or charging with electricity.

⚠ (This operation is not required after delivery, please use it under engineer's instruction if needed.)

Input Signal Setting

- ◆ Under normal test status of positioner, press A/M button for 4s to enter into parameter setting status; the "U0" data value will be displayed. Select "U5" parameter by pressing A/M button, Press ▲ or ▼ button to modify value of "U5" to be 011.1. (See the No. Meaning in the following table for reference)
- ◆ Enter into "U8" parameter value to adjust zero position of input current; When setting, input the zero position through external instrument (4mA usually), then press A/M button for confirmation, Then enter into "U9" parameter.

| Parameter | Display Value | Meanings |
|-----------|---------------|--|
| U5 | 0xx.x | Enter into password setting. U5=011.1, enter into input current setting ; U5=001.1, enter into output current setting; U5=003.1, enter into zero, full position setting of actuator. |
| U6 | xxx.x | Zero-Position Confirmation Parameter of Actuator |
| U7 | xxx.x | Full-Position Confirmation Parameter of Actuator |
| U8 | xxx.x | Zero-Position Parameter Adjustment of Input Current |
| U9 | xxx.x | Full Range Parameter Adjustment of Input Current |
| Ua | xxx.x | Zero-Position Parameter Setting of Output Current |
| Ub | xxx.x | Full Range Parameter Setting of Output Current |
| Uc | xxx.x | Inside Temp. Adjustment |

- ◆ "U9" parameter is the full-range adjustment of input current: During adjustment, input the full-range signal (usually 20mA) through external instrument, press A/M button for confirmation, then enter into "U5" parameter to modify U5=000.5, press A/M button for confirmation and exit. The setting will be finished.

Output Signal Setting

- ◆ Make sure the cleanness and stability of input signal during the operations above.
- ◆ Enter into U5 parameter, correct U5=001.1, press A/M button to enter U6 parameter.
- ◆ Skip parameter U5, U6, U8 to enter into Ua.
- ◆ "Ua" is the zero-position setting of output current: During setting, press ▲ and □ to set output 4mA or other value. The value will be corresponding to the zero-position output signal value of actuator, press A/M button to confirm and then enter into Ub parameter.
- ◆ "Ub" parameter output current range setting: Press ▲ and □ to set the output 20mA or other value. The value will be corresponding to the full-position output signal value of actuator, press A/M button to confirm and then enter into Uc parameter.
- ◆ "Uc" parameter is to modify the temperature inside the cover. Press ▲ and □ for adjustment.
- ◆ Press A/M button for confirmation. Then return to "U5" parameter. Modify "U5" value, make U5=000.5. Press A/M button to confirm and back to test status.

Failure and Countermeasure

| Failure Status | Reason | Countermeasure | |
|---|---|---|--|
| Motor doesn't rotate | The power supply and voltage is low, or no power supply | Check power and voltage | |
| | Input signal suspends or the value is not enough | Check input signal | |
| | Break line is separated from terminal stand | Connect wire and replace terminal stand | |
| | Temperature protector works | Lower the ambient temperature | |
| | | Reduce use frequency | |
| | | Load is too heavy | |
| | Limit switch actions at the middle openness | Adjust stroke blocker | |
| | Capacity used for motor enter-phase is damaged | Replace the capacity | |
| | Motor is disconnected | Replace the motor | |
| Control box is damaged | Replace the control box | | |
| The openness varies continuously | There is interruption signal in signal source | Check input signal | |
| | The interruption is produced from potentiometer | Replace potentiometer | |
| | The gear of potentiometer or opening are loosened | Check screw of tightening gear | |
| The input signal doesn't conform with opening | Input signal is wrong | Check input signal | |
| | Adjustment of zeroing, multiplying-power has problem | Readjust multiplying-power to zero position | |
| | Position of potentiometer gear is changed | Readjust the potentiometer gear | |
| No opening signal | Opening signal line is disconnected or connection has problem | Check wiring | |